

Please read this manual carefully before installation and keep it for future reference.

Installation Manual



MRCOOL®

COMFORT MADE SIMPLE

MB176 Mini-Split Condenser Mounting Bracket

Caution: Do not exceed the weight limit below, serious injury or property damage may occur. Weight Limit = 176 lbs

For more info visit www.mrcool.com

Contents

!	Safety Precautions	2
1	Component Checklist	3
2	Support Assembly	4
3	Installation Of The Bracket	5
4	Mounting the Air Conditioner	7

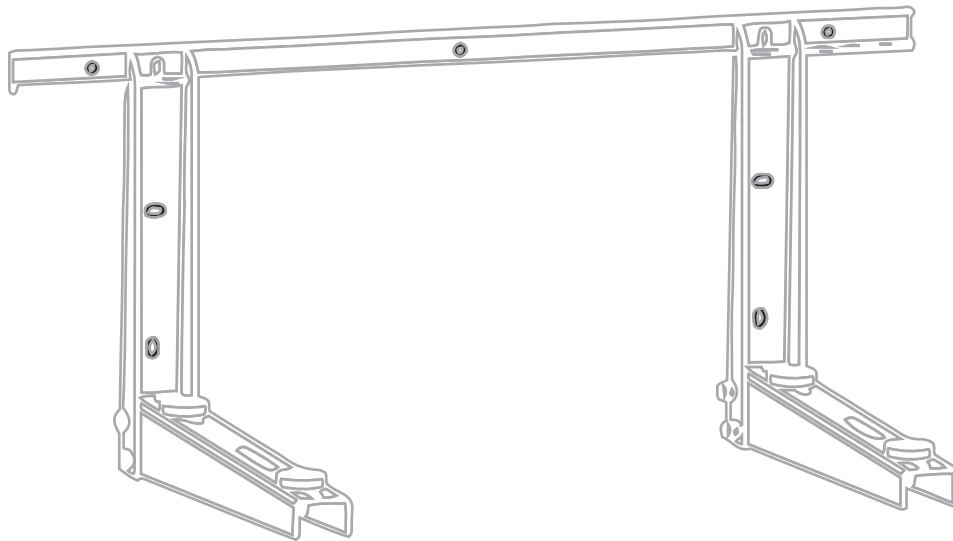

Safety Precautions



Read Before Using

Incorrect usage may cause serious damage or injury.

The seriousness of potential damage or injuries is classified as either a **WARNING** or **CAUTION**.



WARNING

This symbol indicates that ignoring instructions may cause death or serious injury.



CAUTION

This symbol indicates that ignoring instructions may cause moderate injury to your person, damage to your unit, or other property.



This symbol indicates that you should ***NEVER*** perform the indicated action.







WARNING

- This bracket is rated for 176 lbs (80 kg). Do not exceed this limit. If the rated weight limit is exceeded, serious property damage or personal injury may occur.
- This ductless mini-split condenser mounting bracket is intended only for use as specified. Improper usage may result in property damage or physical injury.
- Read and comprehend all installation instructions before beginning product installation. If you have questions about the installation, please contact your dealer or MRCOOL Support at 270-366-0457.
- The installation of this product requires basic mechanical skills and a full understanding of the installation manual.
- Before connecting the condenser bracket to the supporting surface, ensure the surface will support the combined weight of the bracket, the mini-split condenser, and attached components.
- To safely lift and position the bracket, an assistant or mechanical lifting equipment can be useful.
- When tightening screws, do not over tighten. Over tightening may cause long term damage to support structures, and reduce their support capacity.
- The bracket is not intended for any use other than the support of a ductless mini-split condenser.
- Check the bracket every three months to ensure it remains secure and safe to use.

Component Checklist

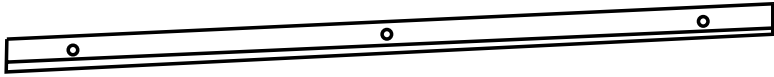
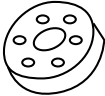
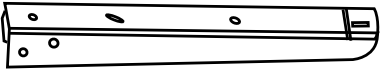
1

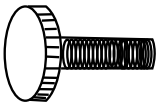
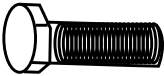
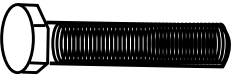
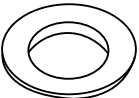
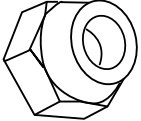
Before beginning installation, review all components to ensure the process can be completed successfully. If any parts are missing or faulty, please contact your dealer or MRCOOL Support at 270-366-0457.

PART	LOOKS LIKE...	QUANTITY	
Wall Plate A		1	
Component B		4	
Component C		2	
Component D		2	
Component E		2	
PACKAGE M	Component M8x25 M-A		4
	Component M8X55 M-B		4
	Component D8 M-C		4
	Component M8 M-D		8
PACKAGE W	Component W-A		5

Begin the installation process by assembling the support mounts.

1. Position one Component C support and one Component D support in such a way that the Component C support is standing upright on its rectangular base and the Component D support is lying perpendicular with the square base of Component D intersecting Component C's interior.
2. The four bolt holes near the base of Component C should be properly aligned with the four bolt holes near the square base of Component D.
3. Take two Component M8x55 M-B bolts and two Component M8 M-D nuts. With the Component C support standing upright and the Component D support pointed toward you, insert one Component M8x55 M-B bolt in the top bottom hole, then tighten one Component M8 M-D nut over the exposed end of the bolt extending out of the opposite side of Component C. The bolt should also extend through the top hole of Component D.
4. Take the second Component M8x55 M-B bolt and extend it through the lower hole on Component C. Attach the Component M8 M-D nut to the end.
5. Do not overtighten the nuts.
6. Next, take one Component E and insert it into the singular hole at the base of the upright Component C support.
7. Finally, assemble two Component M8-25 M-A bolts, two Component B washers, two Component D8 M-C washers, and two Component M8 M-D nuts. Push the M-A bolt through the B washer, then insert it through the innermost slide hole in Component D. Place the M-C washer on the base of the M-A bolt, then secure it in place with an M-D nut. Do not overtighten.
8. Repeat this process for the second set of components and insert them in the outermost slide hole in Component D.
9. This completes the assembly for one of the support mount.
10. Repeat the process to assemble the second support mount.

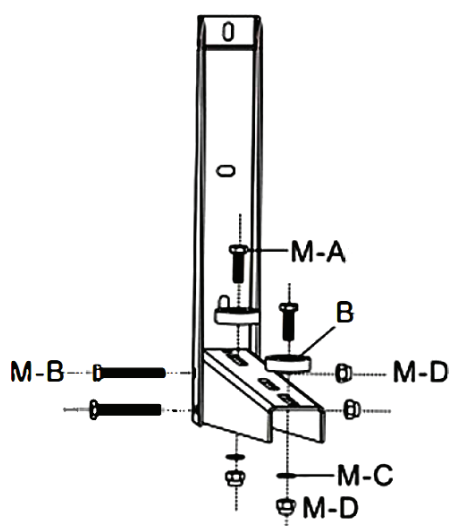

Fig. 2.1

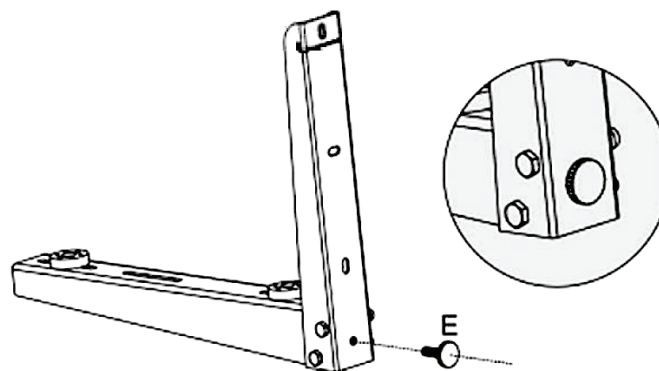
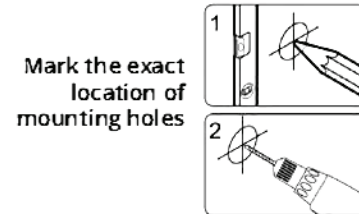
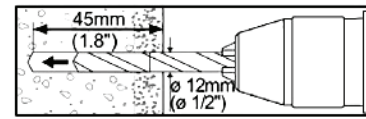
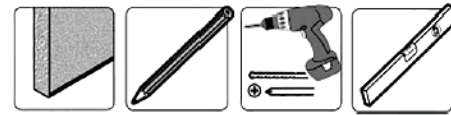

Fig. 2.2

To properly install the bracket on a brick and concrete structure, you will need an install site with a structure strong enough to support the bracket and the condenser, a pencil to mark, a hand-held drill, and a level.

1. Use Wall Plate A and a pencil to mark the location of the mounting holes. Use a level to ensure the mounting holes are properly aligned.
2. After the holes are marked and aligned, use a hand held drill with a 0.5 inch (12mm) drill bit to drill a hole approximately 1.8 inches (45mm) deep.
3. Insert one Component W-A into the center mounting hole. Align Wall Plate A with the insert Component W-A and the other two mounting holes. The thick side of Wall Plate A should be on the bottom and parallel to the ground.
4. Attach a washer and a nut to Component W-A. Do not overtighten the nut.
5. Slide one previously assembled support mount onto the lip of Wall Plate A from the left.
6. Slide the other previously assembled support mount onto the lip of Wall Plate A from the right.
7. Mark four new mounting holes. Two mounting holes should be marked for the left support mount and two should be marked for the right support mount.
8. Remove the support mounts.
9. Using the same drill bit and drill depth as before, drill four mounting holes at the previously marked locations.
10. Insert one Component W-A into each of the four mounting holes.
11. Slide one previously assembled support mount onto the lip of Wall Plate A from the left.
12. Slide the other previously assembled support mount onto the lip of Wall Plate A from the right.
13. Align the support mounts with the mounting holes and the inserted components. Attach a washer and a nut to each Component W-A. Do not overtighten the nuts.



Mark the exact location of mounting holes

Drill pilot holes



Screw the wall mount onto the wall

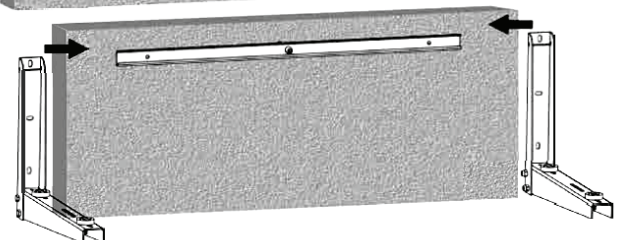
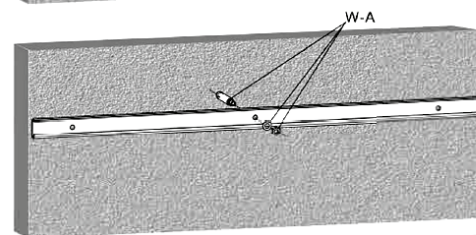
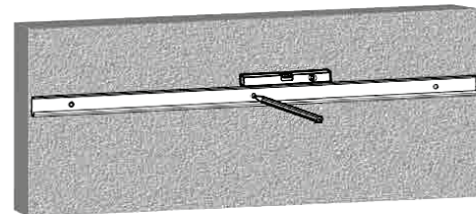
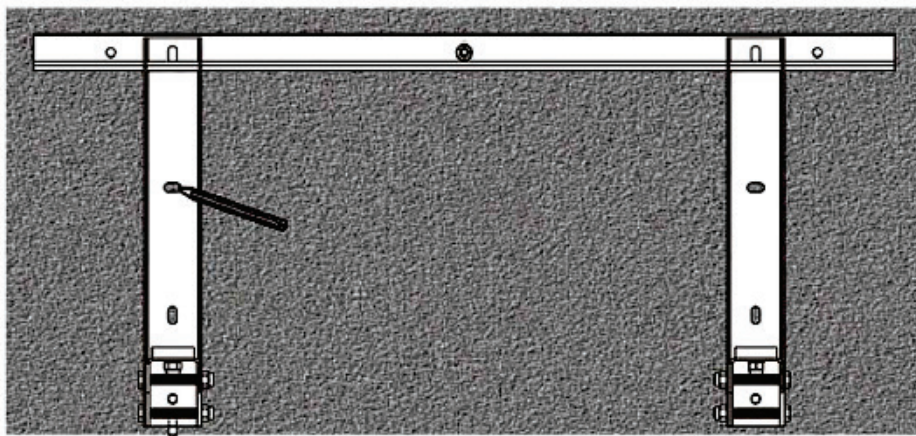
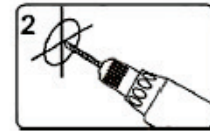

Fig. 3.1

Installation Of The Bracket



Mark the exact location of mounting holes.



Drill Pilot Holes.

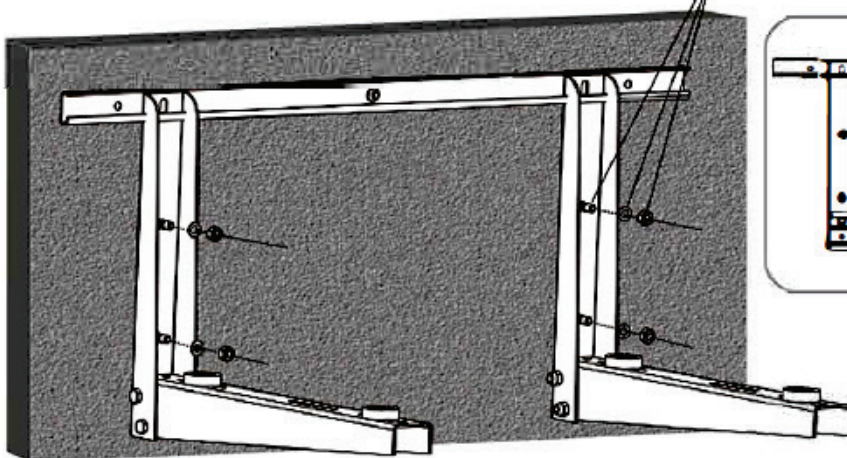
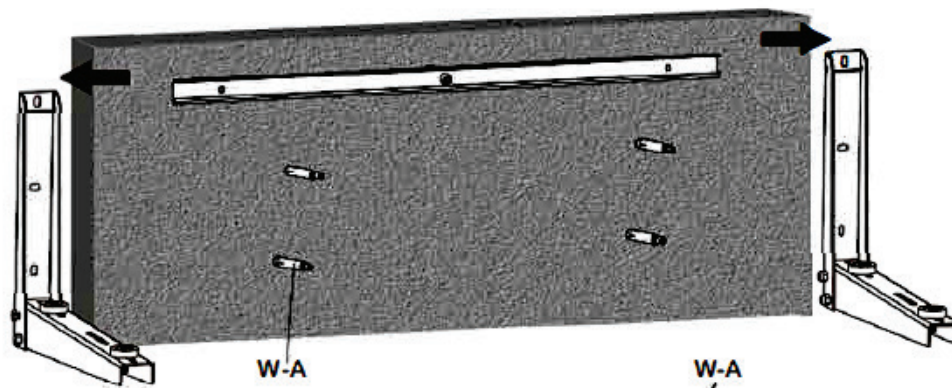

Fig. 3.2



CAUTION

Installers must verify that the supporting surface will safely support the combined weight of the equipment and all attached hardware and components.

Slowly put the air conditioner on the Installed mounting bracket and make sure the air conditioner is firmly supported by the mounting bracket.

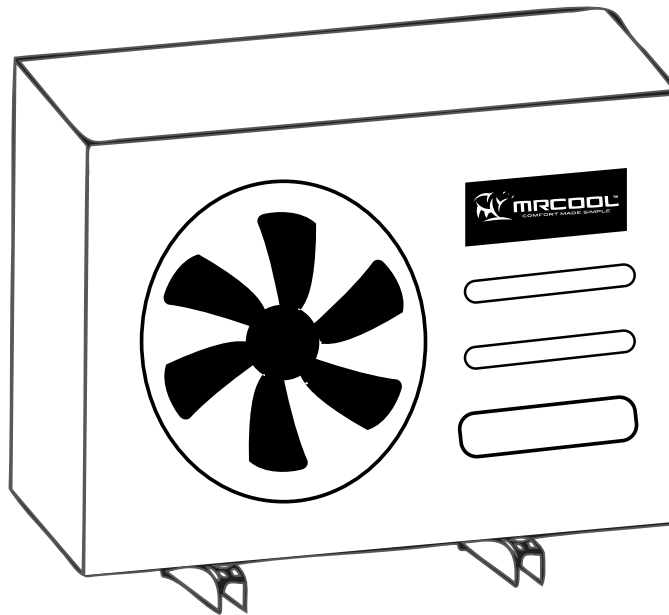

Disclaimer: Air Conditioner not included with bracket.

Maintenance

- Check that the bracket is secure and safe to use at regular intervals.
- Please contact your distributor if you have any questions.



MRCOOL®

COMFORT MADE SIMPLE

MB176 Mini-Split Condenser Mounting Bracket

The design and specifications of this product and/or manual are subject to change without prior notice. Consult with the sales agency or manufacturer for details.